

# Booster Header A1 Artwork Template

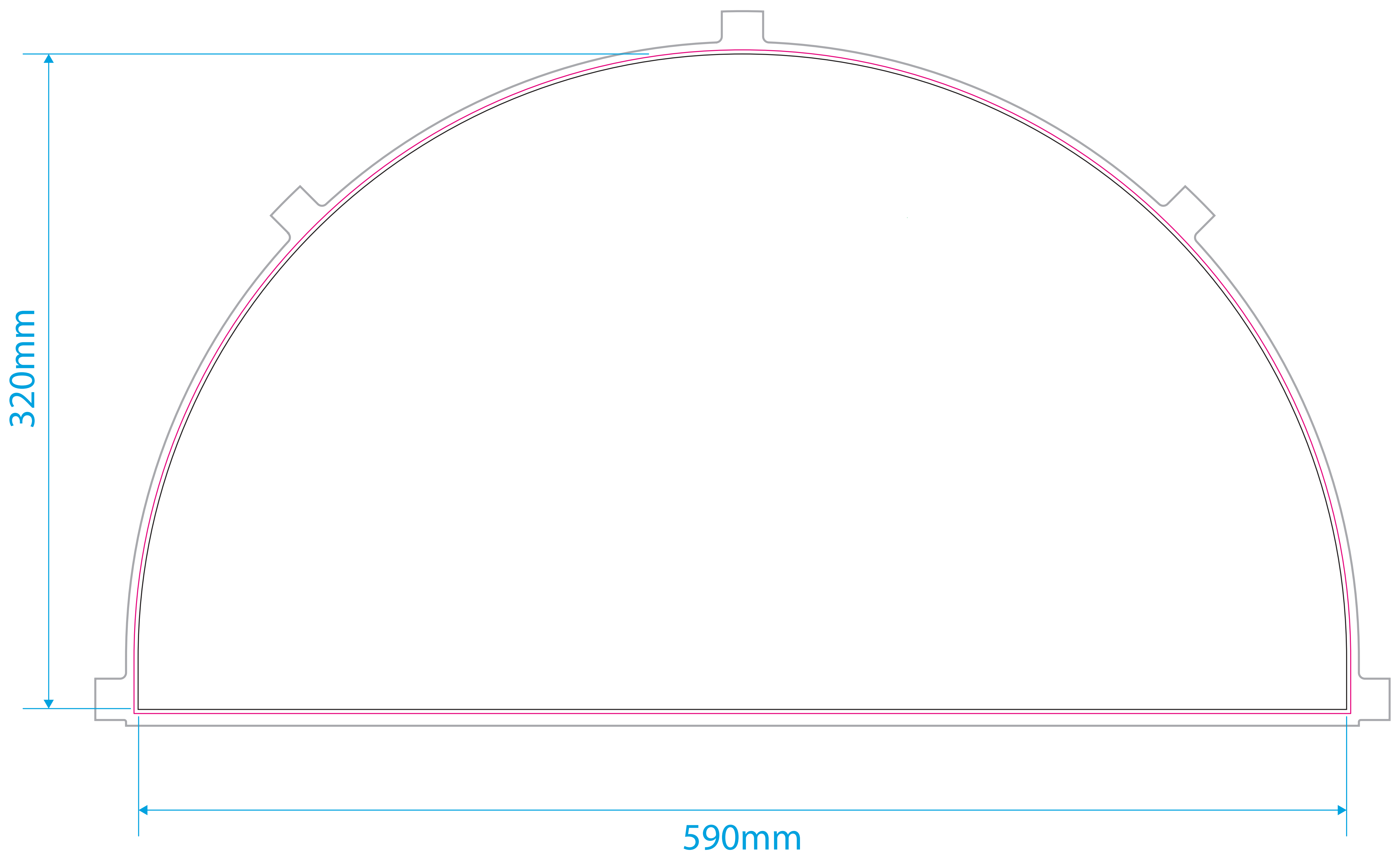

## Template guidelines - PLEASE READ

— The **Black** keyline = Finished cut size of the product before assembly.

— The **Pink** keyline = Your background must extend to this line.